

49. 7079/49. 7080/49. 7081

Eastbrook 
Eastbrook Road, Gloucester GL4 3PB
Technical HelpLine 01452 317890
email:technical@eastbrook.com

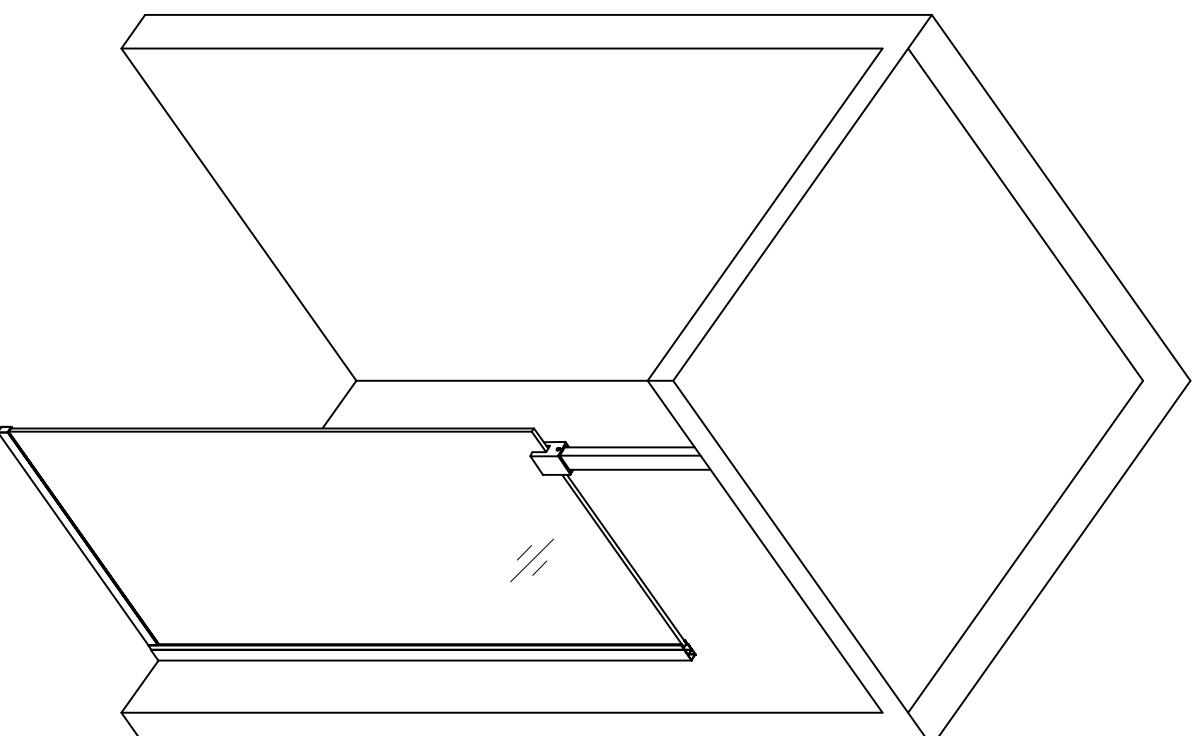

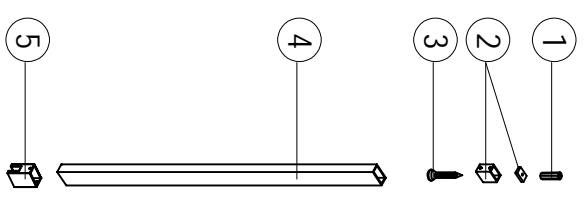

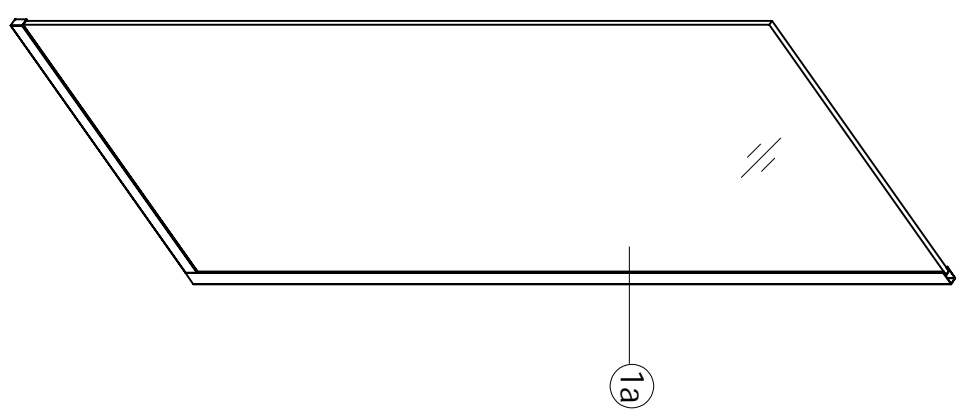

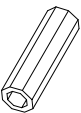

Door

1a

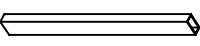

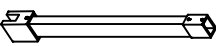
1	 <p>ACARM-CP</p>	2	 <p>CAC-X01</p>	3	 <p>ST4X30</p>	4	 <p>CAC-B01</p> <p>600</p>	5	 <p>CAC-X02</p>	 <p>2 + 4 + 5</p>
D6x30	1Pcs	CAC-X01	1Pcs	ST4X30	1Pcs	CAC-B01	1Pcs	CAC-X02	1Pcs	

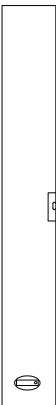
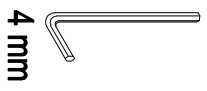
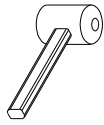
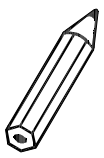
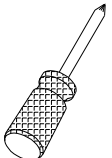
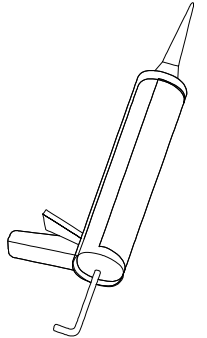

Ø6mm

Ø3.2mm

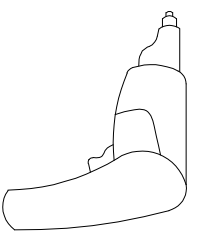
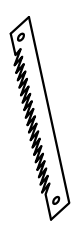
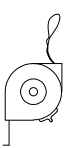

1

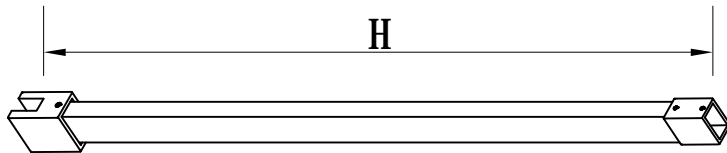
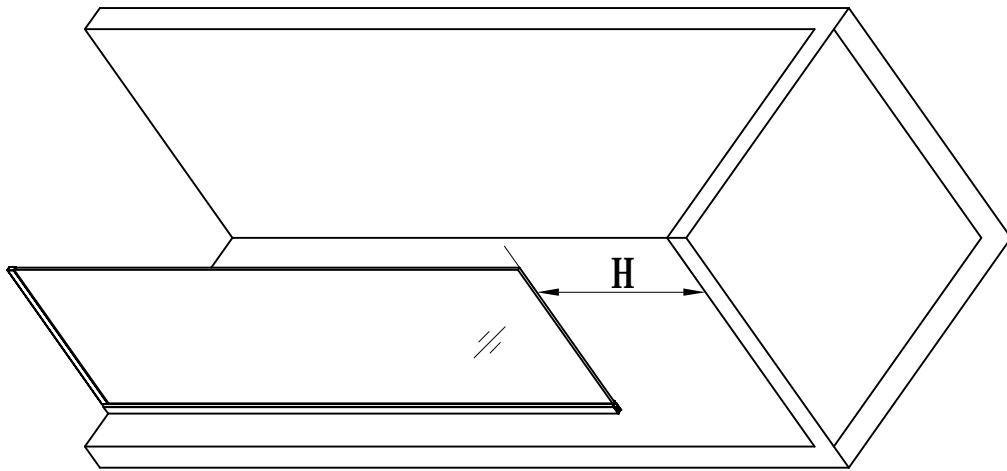

2

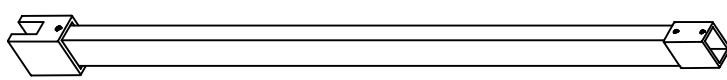
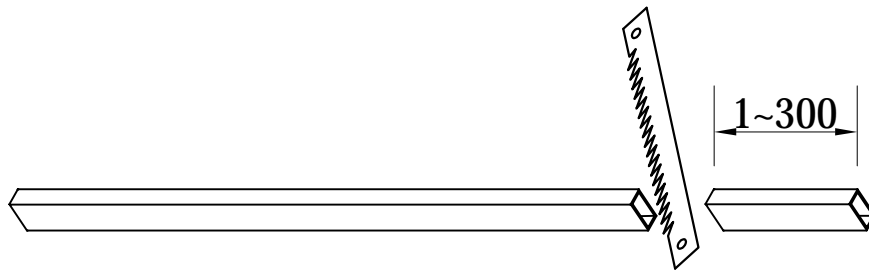

3

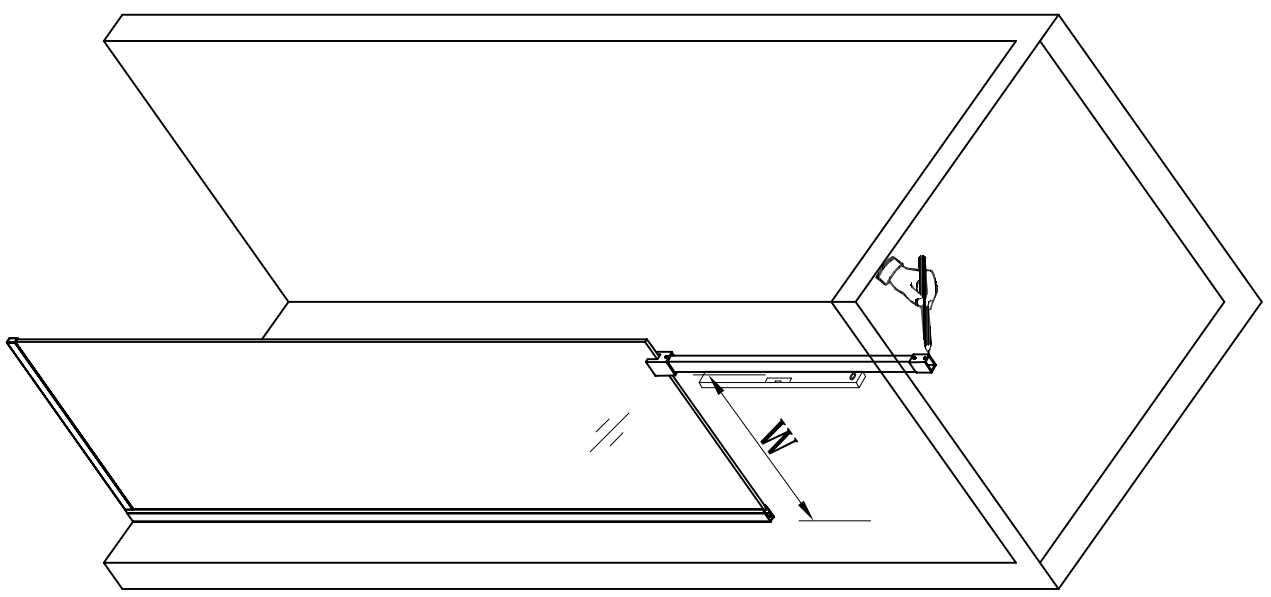

	W
700	600
800	700
900	800
1000	900
1100	1000
1200	1100
1400	1300

3-1



3-2



3-3



3-4

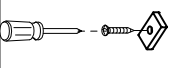

4

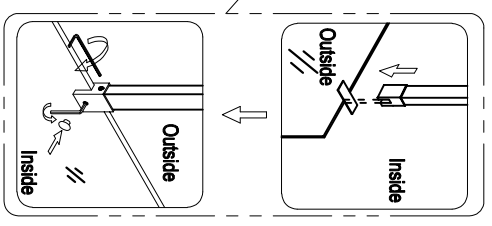
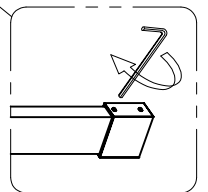
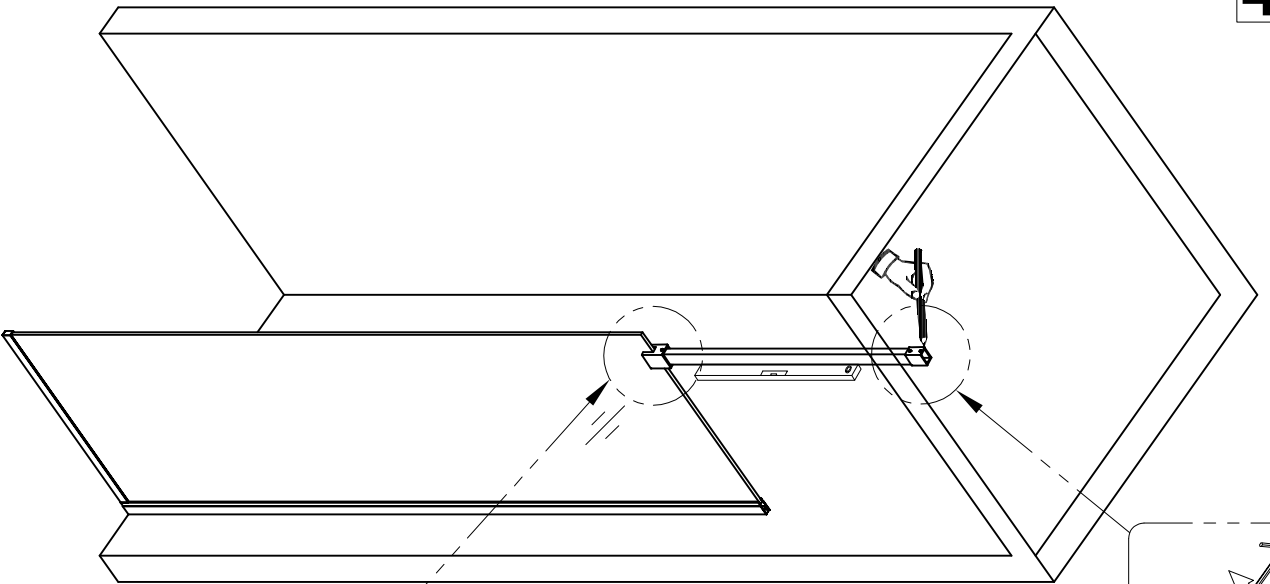

Care Instructions:

Do not use your shower enclosure within 24 hours of assembly . Do not use caustic cleaning products or abrasive material when cleaning your shower enclosure.

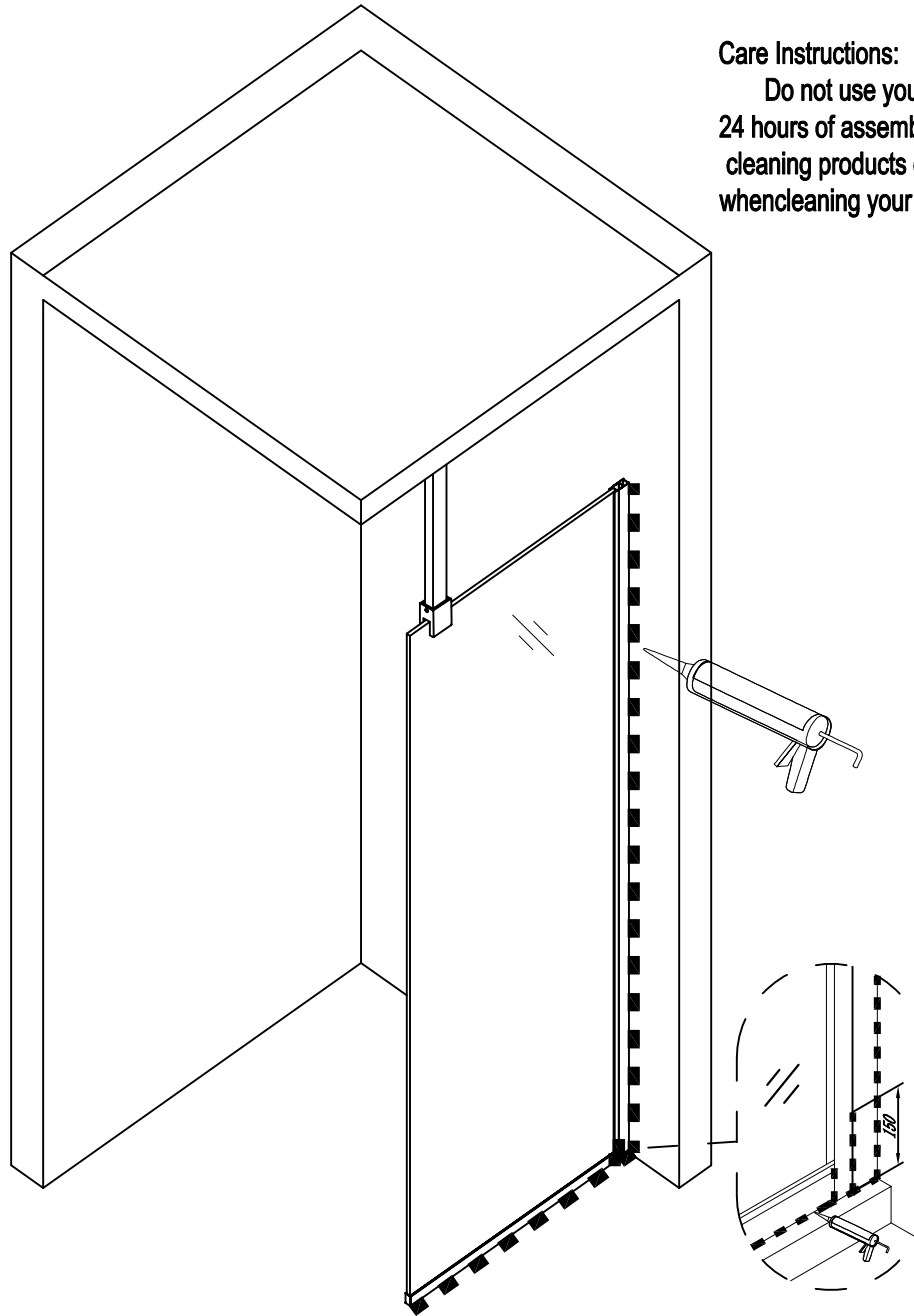



Eastbrook Road, Gloucester GL4 3DB

Technical Helpline: 01452 317890

Email: technical@eastbrookco.com

Cleaning and Maintenance of Shower Enclosures

Do not clean the shower enclosure with irritant detergents such as alcohol, bleach or other chemical cleaners.

Only clean with mild soapy water or a proprietary cleaner where the label advises it is suitable for the materials the enclosure is constructed from. Test on a small area first.

For treating limescale we would recommend distilled vinegar in a half and half solution with water.

Following installation should you find that there is a notable noise when the glass door moves you may add a small amount of silicon lubricant onto the roller wheels and tracks, hinges or clips.

It is the responsibility of the product owner to maintain the product as recommended above. Also, to check for parts which have broken or become loose to protect against failure of the enclosure.